

**NEMA 4/12 - ENCLOSURE
19" RACKMOUNT - 39U HEIGHT
WALL MOUNT**

**72" H x 24" W x 24" D
1 DOOR DESIGN**



FILE NUMBER: E507642

- ENCLOSURE MATERIAL**
- POWDER COATED STEEL (CS)
 - POWDER COATED ALUMINUM (AL)

- POWDERCOAT COLOR**
- WHITE
 - LIGHT GRAY ANSI 70
 - DARK GRAY ANSI 61 (STANDARD)
 - BLACK
 - CUSTOM _____

- ENCLOSURE CONSTRUCTION**
- 14 GA THK.
 - 12 GA THK.

- ENCLOSURE DOOR HINGE**
- CONTINUOUS PIANO HINGE (STANDARD)
 - REMOVABLE LIFT OFF HINGE

- WALL BRACKET (OPTIONS)**
- WALL TABS (STANDARD)
 - HEAVY DUTY BRACKETS
 - POLE MOUNT BRACKETS

AIR CONDITIONER (OPTION)
REF. TO PAGE 2

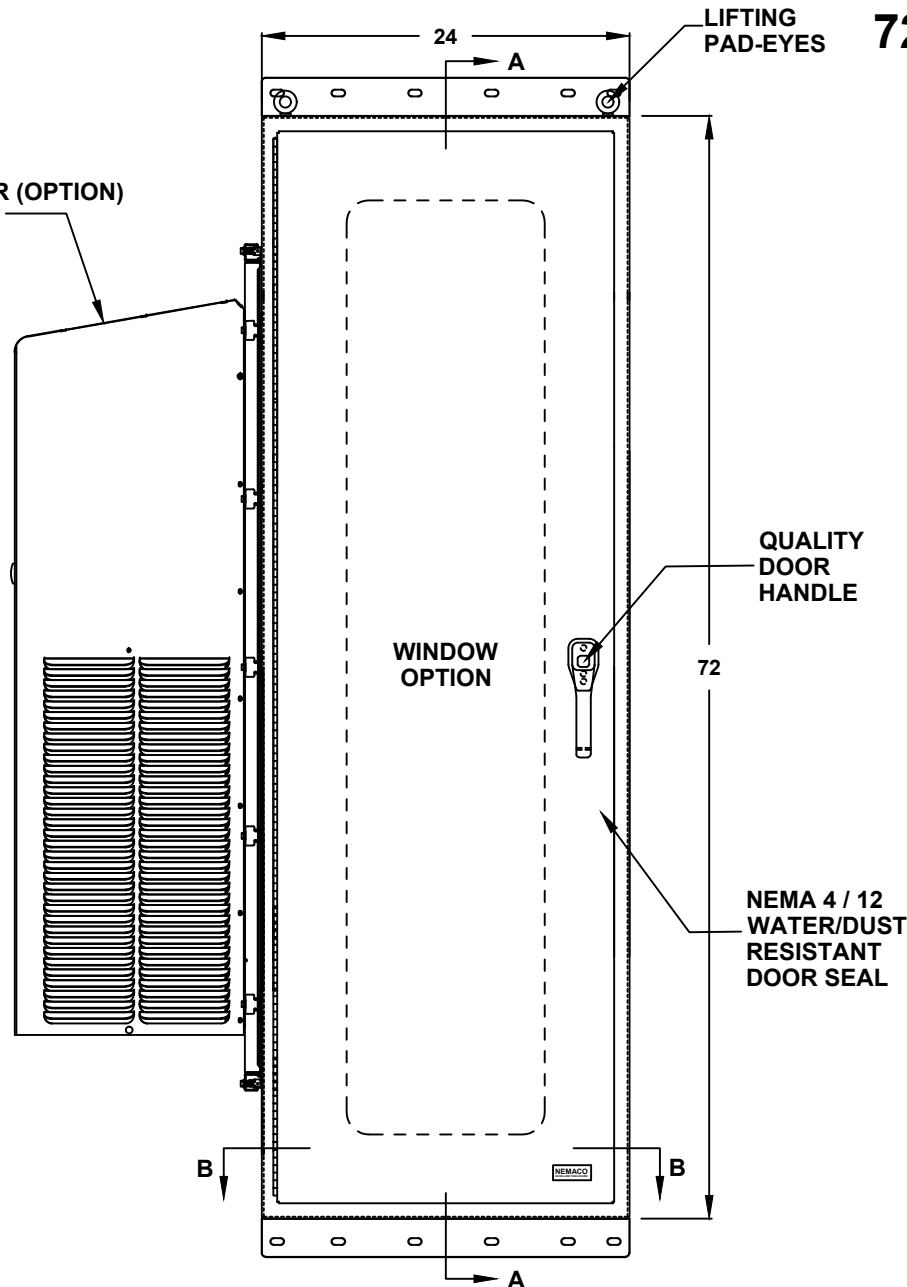

- LIFTING EYES**
- WELDED PADEYES (STANDARD)
 - REMOVABLE PADEYES

- *WINDOW OPTIONS**
- TINTED WINDOW
 - TEMPERED GLASS
 - NOT REQUIRED

- DOOR HANDLES**
- PADLOCK PROVISION (STANDARD)
 - KEYLOCK (OPTION)

ALL DIMENSIONS ARE ESTIMATED IN INCHES
AND MAY VARY DUE TO SELECTED OPTIONS.

*NOTE: UL & NON-UL OPTIONS
AVAILABLE

COMPANY NAME

APPROVED (PRINTED NAME)

SIGNATURE

DATE

FRONT VIEW

**72" H x 24" W x 24" D
1 DOOR DESIGN**

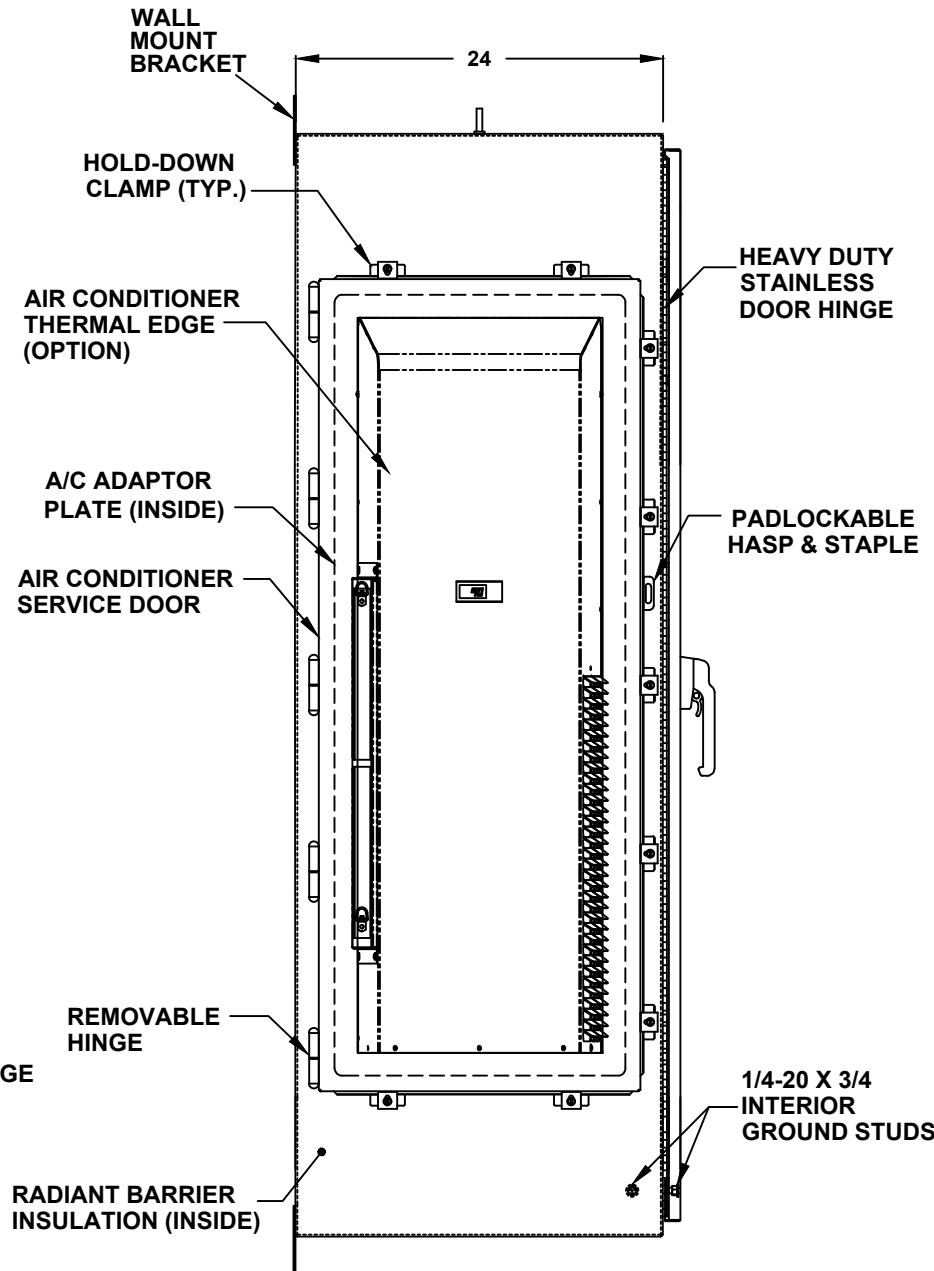

LEFT SIDE

AIR CONDITIONER

- 1000 BTU
- 2000 BTU
- 3000 BTU
- 4000 BTU
- 5000 BTU
- 6000 BTU
- 8000 BTU
- 10000 BTU
- 12000 BTU
- 15000 BTU
- 20000 BTU
- SPECIFY _____
- NOT REQUIRED

A/C VOLTAGE/ HZ

- 115 VOLTS
- 230 VOLTS
- 480 VOLTS
- 60 HZ
- 50 HZ
- 48 VDC (CS011 / NE040 A/C ONLY)

A/C INTEGRATED HEATER

- 350 WATTS (CS011 A/C ONLY)
- 500 WATTS (C3020)
- 1000 WATTS
- EXTERNAL HEATER

ADDITIONAL A/C OPTIONS

- CORROSION PROTECTION PACKAGE
- DRY CONTACT (OUTPUT SIGNAL)
- 2" DEEP FILTERS
- PROXIMITY SWITCH (ON/OFF)

AIR CONDITIONER- SCADA

- MOBUS RTU 485 (2 WIRE)
REMOTE NETWORK
ETHERNET CONNECTION
- MOBUS GATEWAY
ADD-ON

SUN REFLECTIVE SOLUTION

- TOP SUNSHIELD COVER

THERMAL SPECIFICATIONS

- OUTSIDE (AMBIENT) _____ °F
- INTERIOR TEMP. _____ °F
- HEAT LOAD (WATTS) _____
- SUN / SHADE _____

ENCLOSURE INSULATION

- 1/2 RADIANT BARRIER (STANDARD)
- 3/4 RADIANT BARRIER
- 1 RADIANT BARRIER
- NOT REQUIRED

A/C SERVICE DOOR

- INSTALL A/C SERVICE DOOR
- NOT REQUIRED

A/C SERVICE DOOR HINGE

- REMOVABLE HINGE
- CONTINUOUS HINGE

A/C ADAPTOR PLATE

- INSTALL A/C ADAPTOR PLATE
- NOT REQUIRED

RACK RAIL OPTIONS

- BLACK CLIP NUTS, #10-32, (100 EA.)
- #10/32 HIGH POINT SCREWS (100 EA.)
- M6 CAGE NUTS

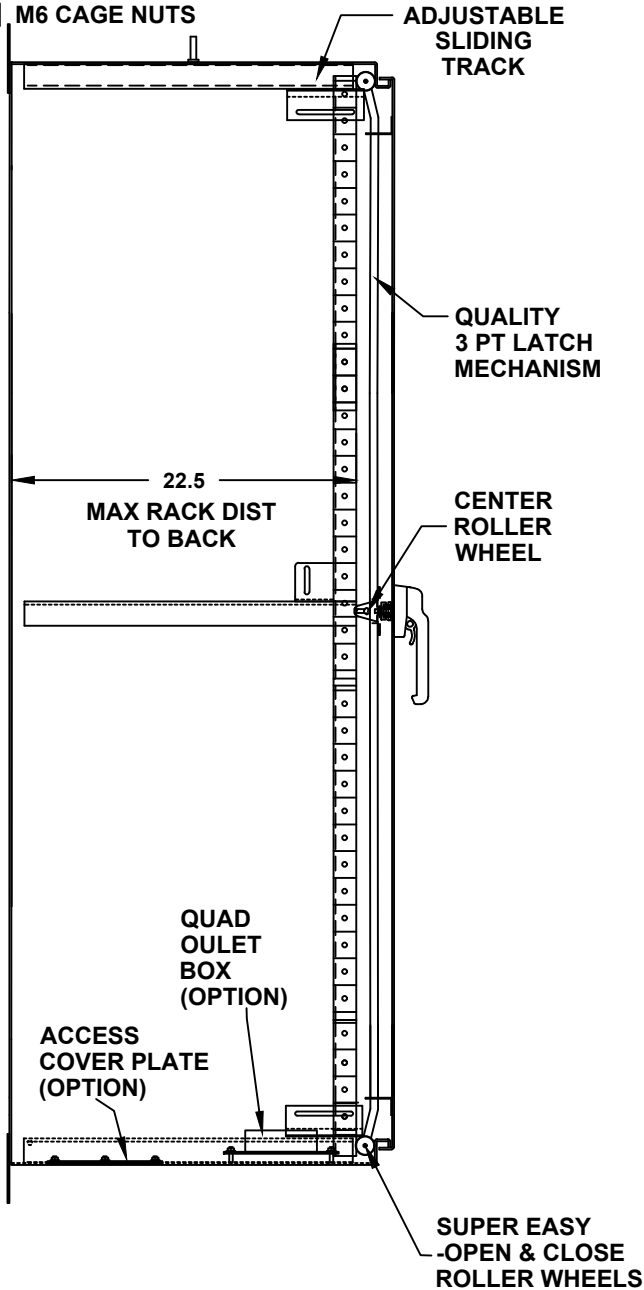

CROSS SECTION VIEW A-A

CONTINUOUS RAIN GUTTER ON ALL 4 SIDES

DOOR SWITCH (OPTION)

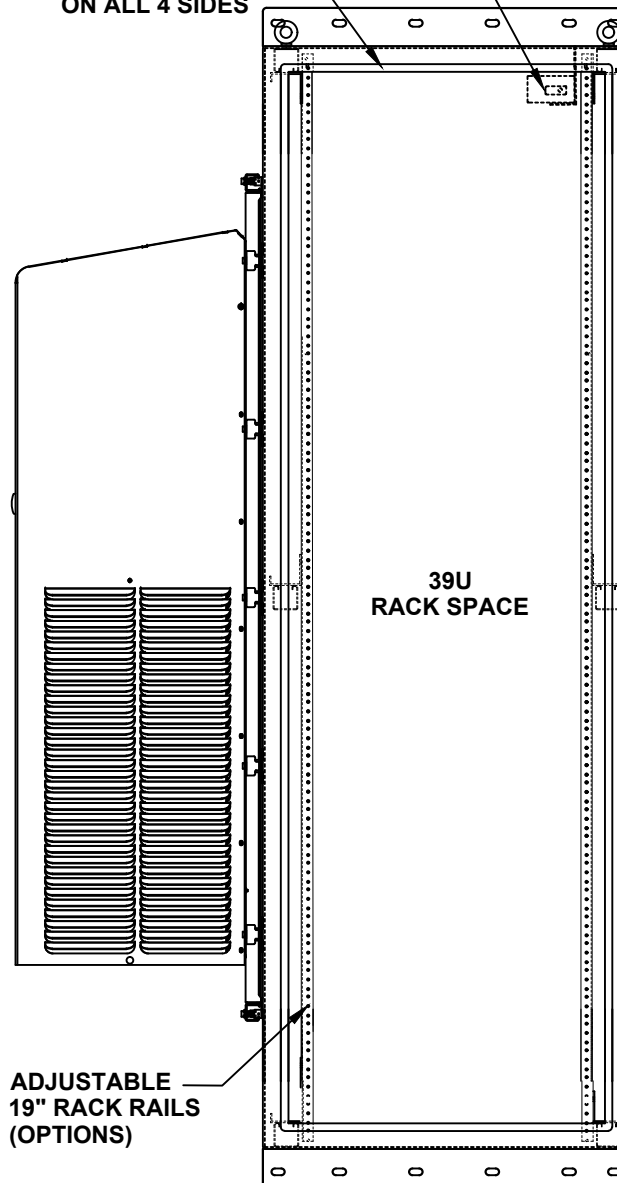

FRONT VIEW WITH DOOR REMOVED

**72" H x 24" W x 24" D
1 DOOR DESIGN**

DOOR OPTIONS

- DOOR SWITCH
- PRINT POCKET

DOOR SWITCH OPTIONS

- 10A (STANDARD)
- 16A

RACK RAIL POST

- QTY 2 POST
- QTY 4 POST (REARDOOR REQUIRED)

RACK RAIL MATERIAL

- POWDER COATED STEEL (STANDARD)
- 304 STAINLESS STEEL

RACK RAIL MOUNTING HOLES

- #10-32 TAP (STANDARD)
- #1/4-20 TAP
- 3/8 SQUARE

RACK RAIL TYPE

- STANDARD GRADE
- HEAVY DUTY RAILS (OPTION)

RACK SHELVES (OPTION)

- STANDARD RACK SHELVES
- SLIDING RACK SHELVES
- RACK SHELF SUPPORT

RACK DRAWERS (OPTION)

- RACK DRAWERS
- LAPTOP DRAWERS

OTHER OPTIONS

- 19" RACK COPPER BUSBAR
- VERTICAL RACK PDU

72" H x 24" W x 24" D 1 DOOR DESIGN

DOOR STOPPER

- INSTALL DOOR STOPPER
- NOT REQUIRED

**BASE ACCESS COVER PLATE
(OPTION)**

- 8x8 PLATE (6x6 CUT-OUT)
- 8x16 PLATE (6x14 CUT-OUT)
- 12x12 PLATE (10x10 CUT-OUT)
- 16x16 PLATE (14x14 CUT-OUT)

SIDE ACCESS COVER PLATE MAT'L

- POWDER COATED STEEL
- POWDER COATED ALUMINUM
- STAINLESS STEEL, 304

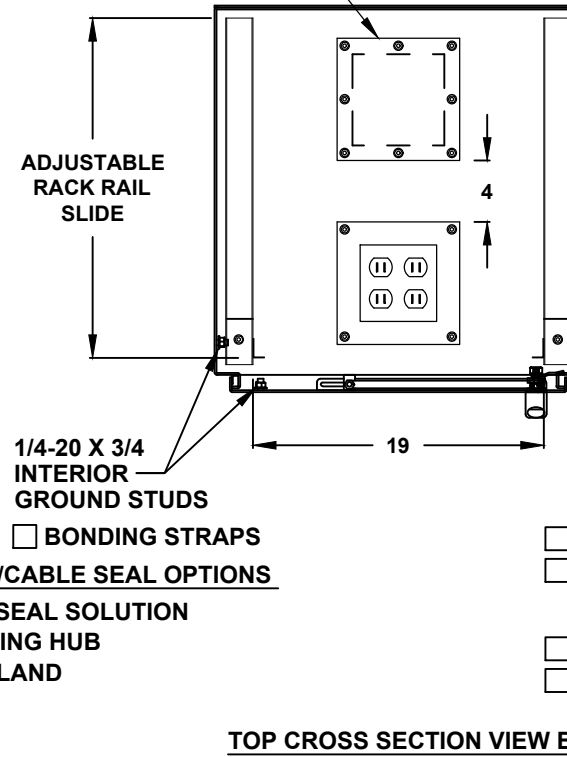
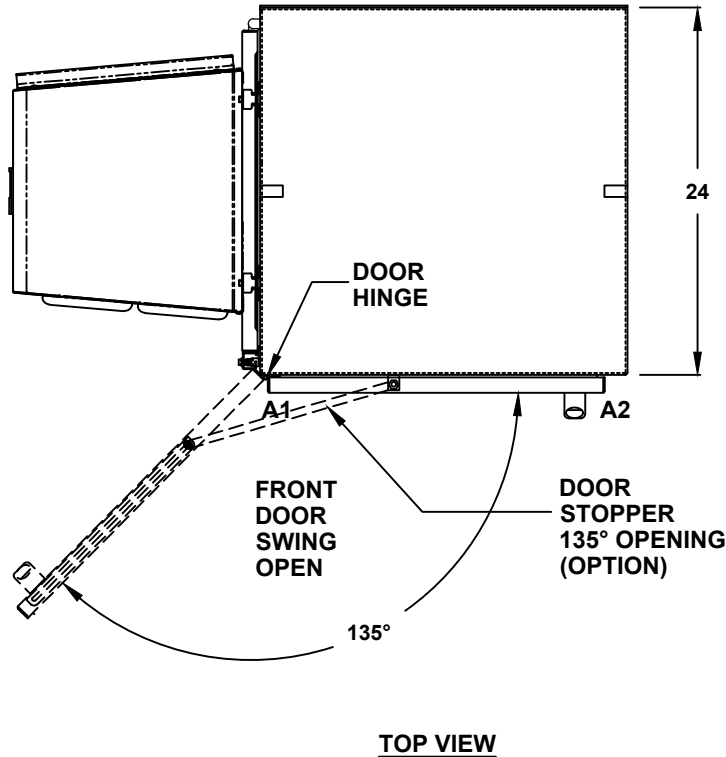

CONDUIT/CABLE SEAL OPTIONS

- ROXTEC SEAL SOLUTION
- PIPE FITTING HUB
- CABLE GLAND

**QUAD OUTLET BOX
ON 8x8 PLATE (OPTION)**

- ADD QUAD BOX
- NOT REQUIRED

OUTLET BOX AMP.

- 15A
- 20A

72" H x 24" W x 24" D

1 DOOR DESIGN

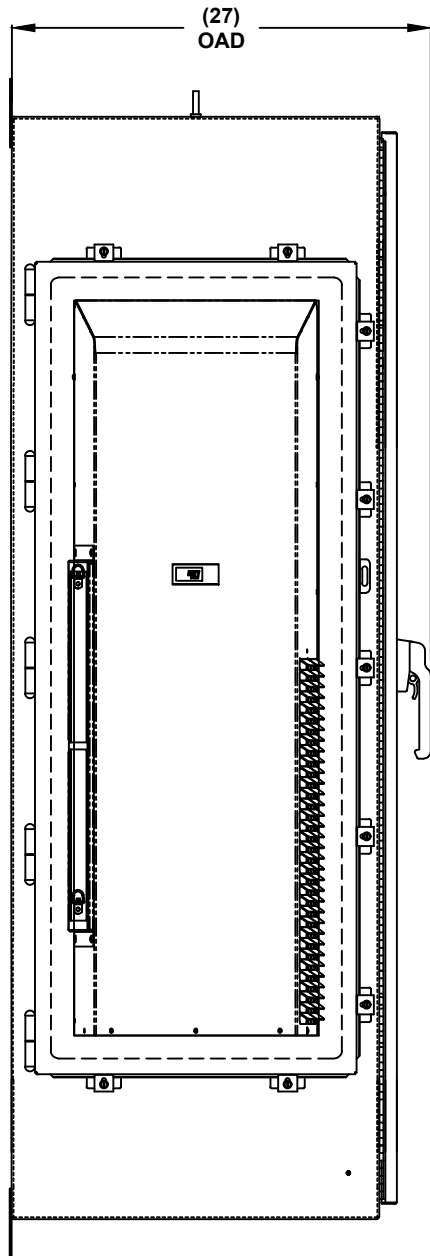

LEFT SIDE

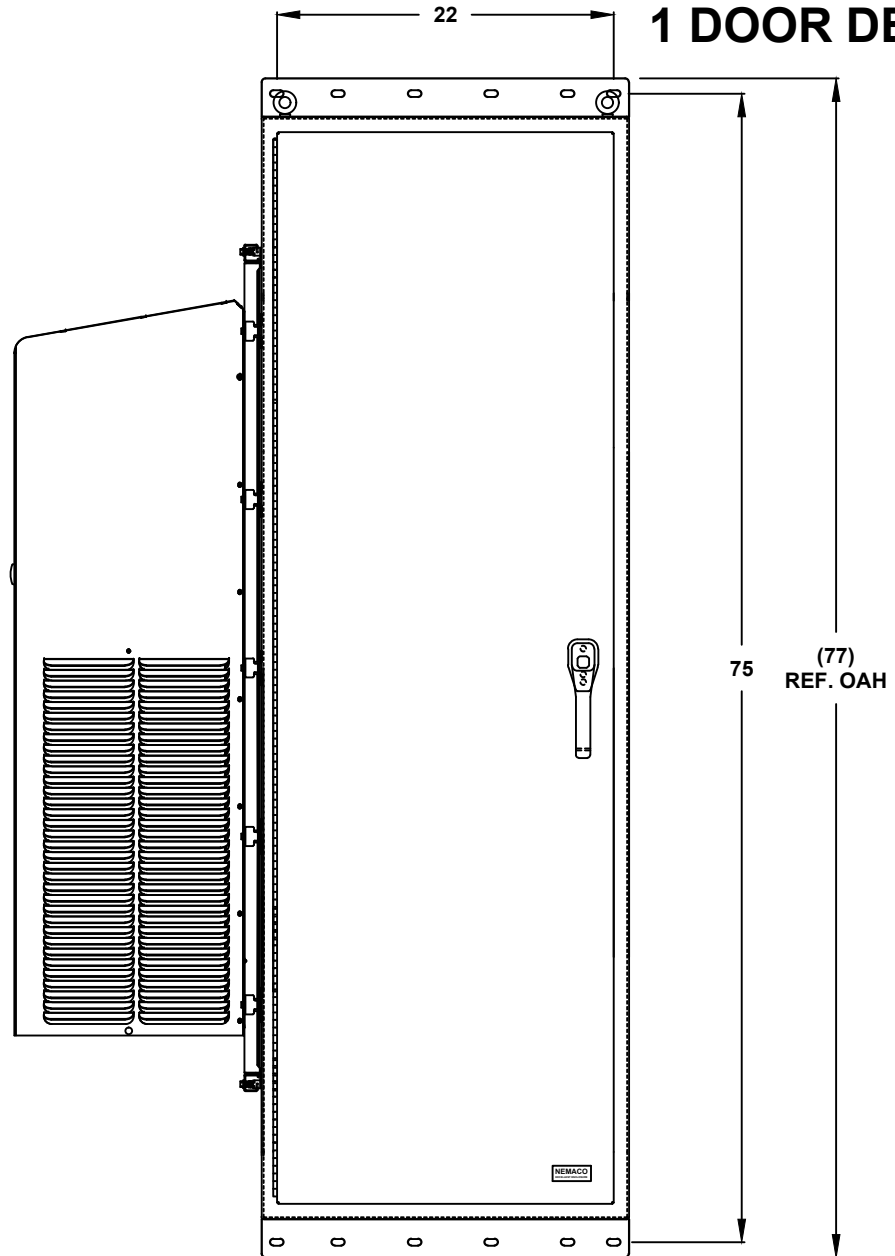

FRONT VIEW